

Bridging data and modeling communities

Michael Blinov

Oliver Ruebenacker

Ion Moraru

BioPAX and BioPAX OBO groups



NRCAM meeting
February 23rd, 2009



Better and reusable representation

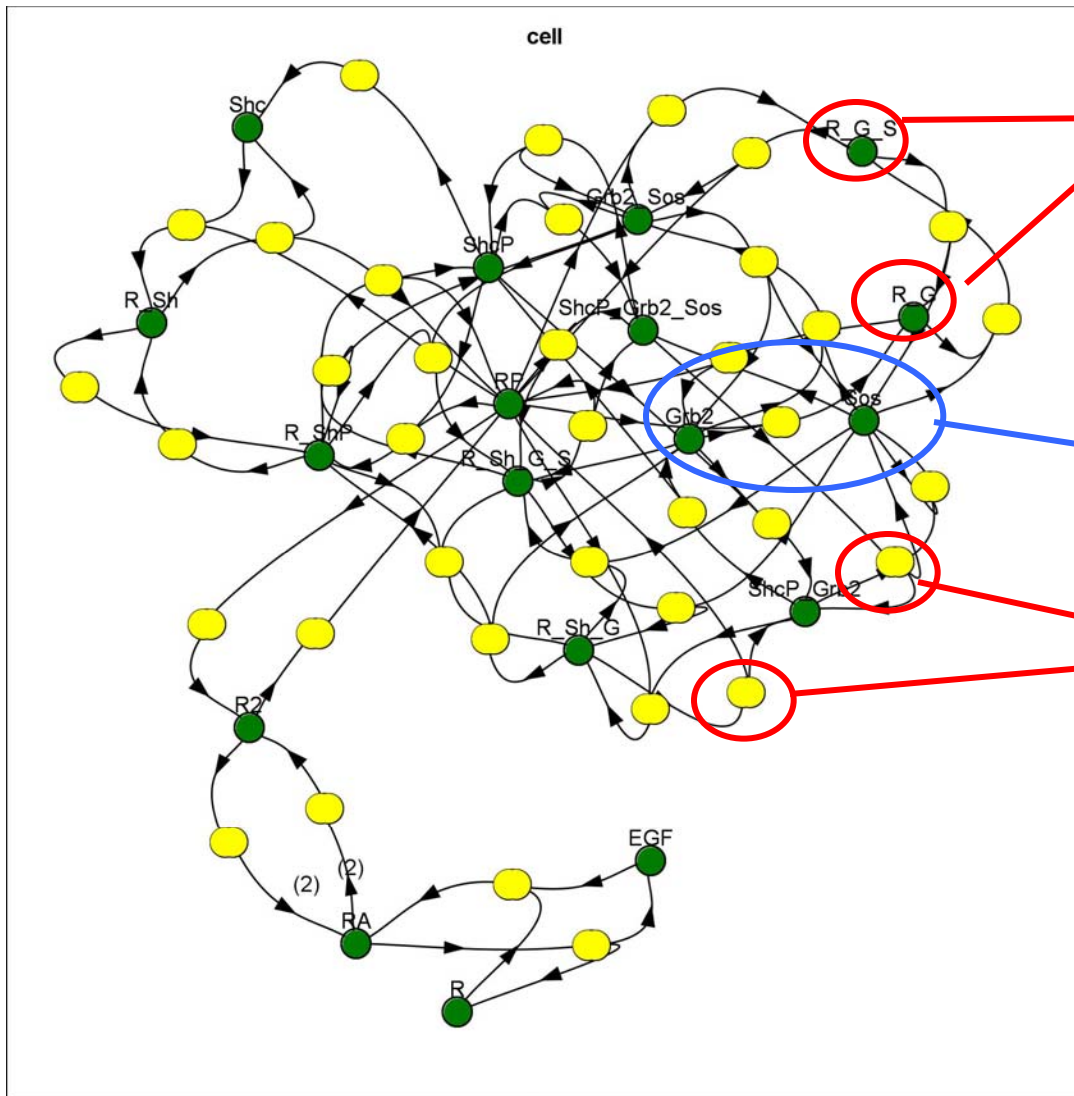

Different types of species: proteins, small molecules, complexes.

User-specified grouping: ligand-binding module, Grb2 interactions

Different types of reactions: biochemical reaction, complex assembly

Model is abstraction of knowledge

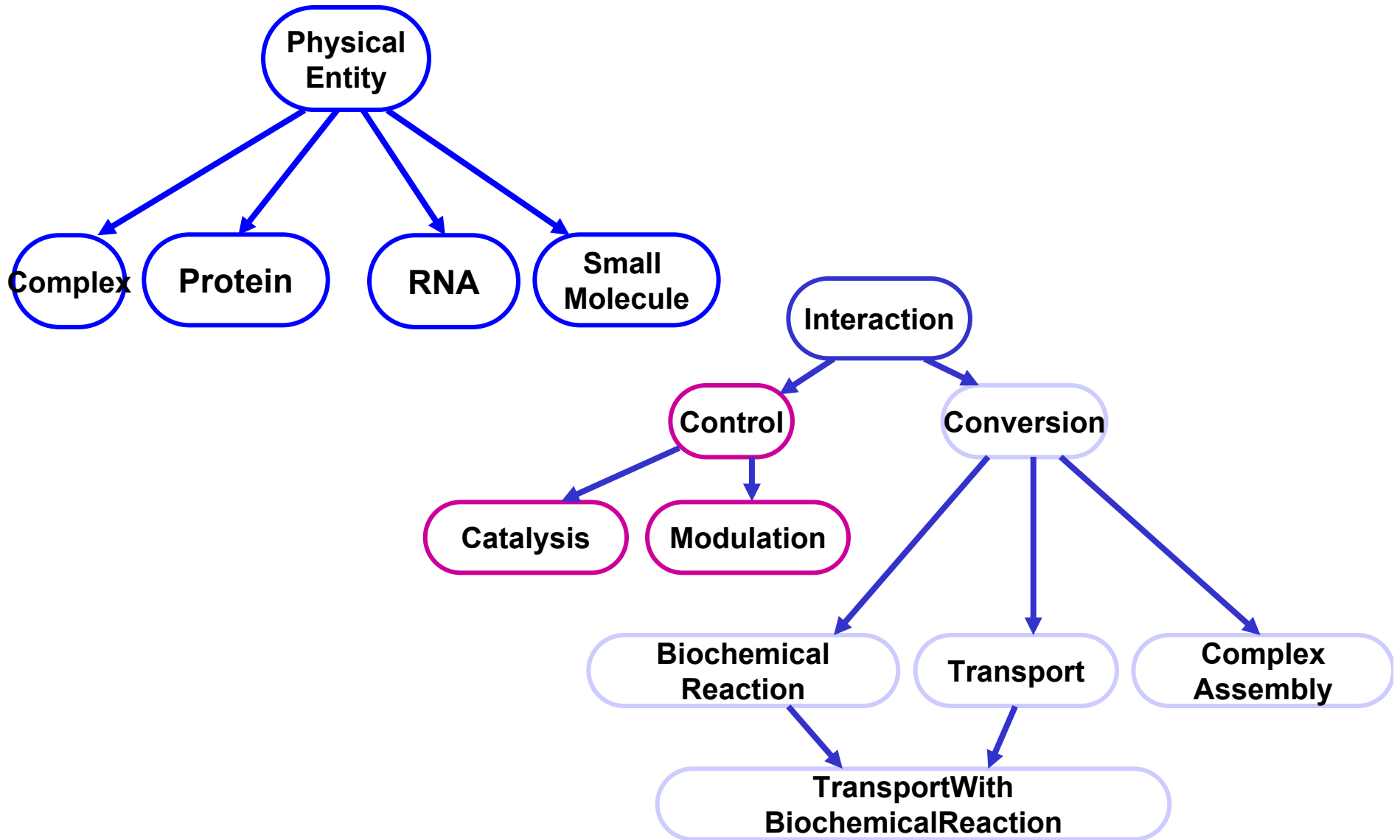

World of models

- Over 100 software tools support import and/or export of models in SBML format
- Database of models in SBML format
<http://BioModels.net> contains more than 200 curated models
- VCell database contain more than 600 publicly available models including about 50 curated models. Many of them can be exported to SBML.

World of pathway databases

Data Source	Protein(SwissProt)	Coverage (SwissProt)	Interaction	Citation
<u>Reactome</u>	1229 (1194)	5% (8%)	21394	Vastrik <i>et al</i> , 2007
<u>Panther</u>	2997 (1670)	12% (12%)	75694	Mi <i>et al</i> , 2007
<u>CellMap</u>	567 (567)	2% (4%)	1195	cancer.cellmap.org
<u>INOH</u>	719 (711)	3% (5%)	11759	Kushida <i>et al</i> , 2006
<u>NCI-Nature</u>	593 (592)	2% (4%)	2900	pid.nci.nih.gov
<u>NCI-BioCarta</u>	936 (936)	4% (6%)	4752	pid.nci.nih.gov
<u>KEGG</u>	2033 (1947)	8% (13%)	11144	Kanehisa <i>et al</i> , 2004
<u>Total</u>	5283 (3847)	21% (27%)	118867	

World of ontologies

BioPAX = Biological Pathway eXchange

GO = Gene Ontology

ChEBI = Chemical Entities of Biological Interest

RO (OBO) = Relation Ontology (Open Biomedical Ontologies)

SBO = Systems Biology Ontology

BFO = Basic Formal Ontology

Two worlds

Modeling Community

- Do the math so that it can be calculated
- Quantities
- Simulate and fit
- Data models

SBML

- System Biological Markup Language
- Quantitative information
- XML
- <http://www.sbml.org/>

Pathway Community

- Link information so that it can be found
- Relationships
- Reason and query
- Ontologies

BioPAX

- Biological Pathway eXchange
- Qualitative, no kinetics
- RDF / OWL
- <http://www.biopax.org/>

Can BioPAX and SBML work together?

Conversions

- Binom (Cytoscape)
- Sbml2biopax

Annotation

- Use BioPAX for annotations in SBML
- Add dummy elements to SBML to describe BioPAX features

Direct conversion may be impossible

- An entity in BioPAX corresponds to multiple species in SBML (e.g. a protein in varying phosphorylation states)
- A species in SBML corresponds to multiple entities in BioPAX (e.g. generic participants in transport, translation and transcription)

Systems Biology Linker (SyBiL)

- <http://vcell.org/biopax>
- SyBiL provides capabilities for:
 - Visualizing, analyzing and querying pathway data represented in BioPAX
 - Creating computational model (SBML) from qualitative description (BioPAX)
 - Converting, gluing and merging data and models about pathways coming from different sources, such as BioPAX and SBML.
 - Intelligent visualizing and modular presentation of VCell model.

Systems Biology Linker (SyBiL)

- <http://vcell.org/biopax>
- SyBiL provides capabilities for:
 - **Visualizing, analyzing and querying pathway data represented in BioPAX**
 - Creating computational model (SBML) from qualitative description (BioPAX)
 - Converting, gluing and merging data and models about pathways coming from different sources, such as BioPAX and SBML.
 - Intelligent visualizing and modular presentation of VCell model.

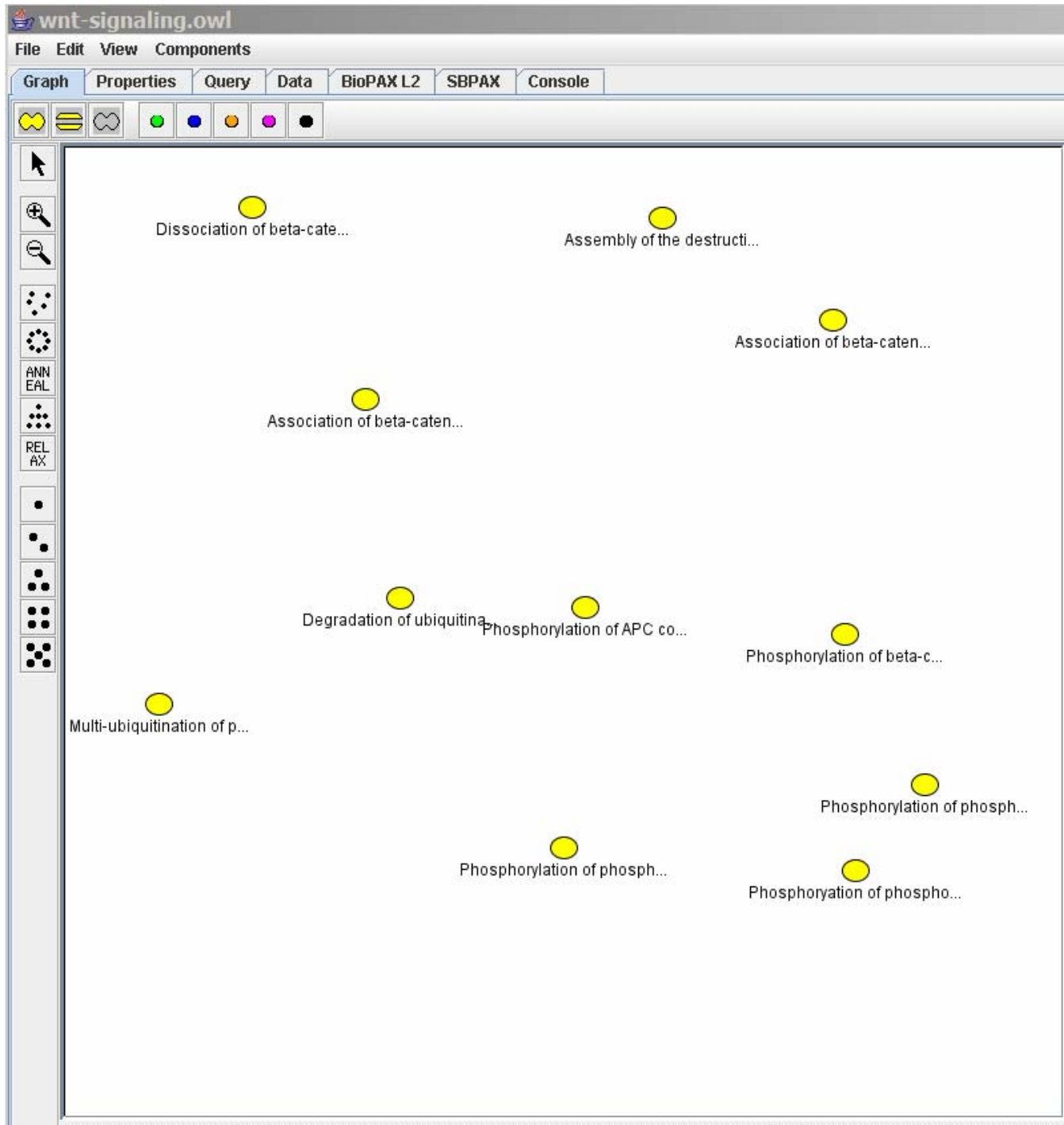

Systems Biology Linker (SyBiL)

- <http://vcell.org/biopax>
- SyBiL provides capabilities for:
 - Visualizing, analyzing and querying pathway data represented in BioPAX
 - **Creating computational model (SBML) from qualitative description (BioPAX)**
 - Converting, gluing and merging data and models about pathways coming from different sources, such as BioPAX and SBML.
 - Intelligent visualizing and modular presentation of VCell model.

wnt-signaling.owl

File Edit View Components

Data BioPAX to SBML Conversion Advanced

Conversion Criteria Reactions and Participants Compartments

Criteria for conversion of BioPAX data to SBML model

Here you can select which Physical Entities Participants in BioPAX file will be converted to separate speciesTypes in SBML file. Depending on whether location is the same or different, Physical Entity Participants are assigned the same or different species. Below you can select assumptions about generic conversion. Later you can override these assumptions.



[More about conversion criteria](#) [More about BioPAX and SBML](#)

None - None of Physical Entity Participants is assigned a separate SpeciesTypes. Manually assign species to each Physical Entity on the next screen.

Some - Some types of PhysicalEntities are directly converted to speciesTypes.

Substance rna dna smallMolecule protein complex

All - All Physiscal Entity Participants are converted to a separate SpeciesType.

 Reset  Process and Proceed

wnt-signaling.owl						
File Edit View Components						
Data BioPAX to SBML Conversion Advanced						
Conversion Criteria Reactions and Participants Compartments						
Process (BP)/ Reaction ID (SB)	Participants in BioPAX	Entity (BP)	Entity Class in BioPAX	Stoich. Coef.	SpeciesType ID	Location (BP)/
Phosphorylation of beta-cate...	ATP_cytosol_	ATP	smallMolecule	1.0	ATP	cytosol
Phosphorylation of beta-cate...	beta_catenin_Axin_GSK3_CK1alp...	beta-catenin:Axin:GSK3:CK1alpha:APC...	complex	1.0	[none]	cytosol
Phosphorylation of beta-cate...	ADP_cytosol_	ADP	smallMolecule	1.0	[new]	cytosol
Phosphorylation of beta-cate...	phospho_Ser45_beta_catenin...	phospho-(Ser45) beta-catenin:Axin:GS...	complex	1.0	[none]	cytosol
Phosphorylation of beta-cate...	Phospho_Ser45_Thr41_Ser3...	Phospho-(Ser45, Thr41, Ser37, Ser33) ...	complex	[none]	beta-catenin	cytosol
Phosphorylation of phospho...	ATP_cytosol_1	ATP	smallMolecule	1.0	ATP	cytosol
Phosphorylation of phospho...	phospho_Ser45_beta_catenin...	phospho-(Ser45) beta-catenin:Axin:GS...	complex	1.0	[none]	cytosol
Phosphorylation of phospho...	ADP_cytosol_1	ADP	smallMolecule	1.0	ADP	cytosol
Phosphorylation of phospho...	phospho_Ser45_Thr41_beta...	phospho-(Ser45, Thr41) beta-catenin:A...	complex	1.0	[none]	cytosol
Phosphorylation of phospho...	phospho_Ser45_beta_catenin...	phospho-(Ser45) beta-catenin:Axin:GS...	complex	[none]	[none]	cytosol
Phosphorylation of phospho...	ATP_cytosol_2	ATP	smallMolecule	1.0	ATP	cytosol
Phosphorylation of phospho...	phospho_Ser45_Thr41_beta...	phospho-(Ser45, Thr41) beta-catenin:A...	complex	1.0	[none]	cytosol
Phosphorylation of phospho...	phospho_Ser45_Thr41_Ser3...	phospho-(Ser45, Thr41, Ser37) beta-ca...	complex	1.0	[none]	cytosol
Phosphorylation of phospho...	ADP_cytosol_2	ADP	smallMolecule	1.0	ADP	cytosol
Phosphorylation of phospho...	phospho_Ser45_Thr41_beta...	phospho-(Ser45, Thr41) beta-catenin:A...	complex	[none]	[none]	cytosol
Dissociation of beta-catenin ...	phospho_Ser45_Thr41_Ser37...	phospho-(Ser45, Thr41, Ser37, Ser33):A...	complex	1.0	[none]	cytosol
Dissociation of beta-catenin ...	phospho_Ser45_Thr41_Ser37...	phospho-(Ser45, Thr41, Ser37, Ser33):A...	complex	1.0	[none]	cytosol
Association of beta-catenin ...	phospho_Ser45_Thr41_Ser37...	phospho-(Ser45, Thr41, Ser37, Ser33):A...	complex	1.0	[none]	cytosol
Association of beta-catenin ...	SCF_beta_TrCP1_complex_cyto...	SCF-beta-TrCP1 complex	complex	1.0	[none]	cytosol
Association of beta-catenin ...	SCF_beta_TrCP1_complex_asso...	SCF-beta-TrCP1 complex associated ...	complex	1.0	[none]	cytosol
Assembly of the destruction ...	GSK3B_cytosol_	GSK3B [cytosol]	protein	1.0	GSK3B [c...	cytosol
Assembly of the destruction ...	CK1alpha_cytosol_	UniProt:P48729 Casein kinase I, alpha...	protein	1.0	UniProt.P...	[none]
Assembly of the destruction ...	APC_cytosol_	APC [cytosol]	protein	1.0	APC [cyto...	cytosol
Assembly of the destruction ...	Axin_cytosol_	UniProt:O15169 Axin 1 (Axin inhibition p...	protein	1.0	UniProt.O...	cytosol
Assembly of the destruction ...	PP2A_cytosol_	PP2A	complex	1.0	[none]	cytosol
Assembly of the destruction ...	Axin_GSK3_CK1alpha_APC_PP2...	Axin:GSK3:CK1alpha:APC:PP2A complex	complex	1.0	[none]	cytosol
Phosphorylation of APC com...	Phospho_Ser45_Thr41_Ser3...	Phospho-(Ser45, Thr41, Ser37, Ser33) ...	complex	1.0	[none]	cytosol
Phosphorylation of APC com...	ATP_cytosol_4	ATP	smallMolecule	1.0	ATP	cytosol
Phosphorylation of APC com...	phospho_Ser45_Thr41_Ser37...	phospho-(Ser45, Thr41, Ser37, Ser33):A...	complex	1.0	[none]	cytosol
Phosphorylation of APC com...	ADP_cytosol_4	ADP	smallMolecule	1.0	ADP	cytosol
Phosphorylation of APC com...	Phospho_Ser45_Thr41_Ser3...	Phospho-(Ser45, Thr41, Ser37, Ser33) ...	complex	[none]	[none]	cytosol
Association of beta-catenin ...	Axin_GSK3_CK1alpha_APC_PP2...	Axin:GSK3:CK1alpha:APC:PP2A complex	complex	1.0	[none]	cytosol
Association of beta-catenin ...	beta_catenin_cytosol_	beta-catenin [cytosol]	physicalEntity	1.0	[none]	cytosol
Association of beta-catenin ...	beta_catenin_Axin_GSK3_CK1alp...	beta-catenin:Axin:GSK3:CK1alpha:APC...	complex	1.0	[none]	cytosol
Multi-ubiquitination of phosp...	SCF_beta_TrCP1_complex_asso...	SCF-beta-TrCP1 complex associated ...	complex	1.0	[none]	cytosol
Multi-ubiquitination of phosp...	ubiquitin_cytosol_	UniProt:P62988 Ubiquitin	protein	4.0	UniProt.P...	cytosol
Multi-ubiquitination of phosp...	ubiquitinated_phospho_beta_cat...	ubiquitinated phospho-beta-catenin:SC...	complex	1.0	[none]	cytosol
Phosphorylation of phospho...	ATP_cytosol_3	ATP	smallMolecule	1.0	ATP	cytosol
Phosphorylation of phospho...	phospho_Ser45_Thr41_Ser3...	phospho-(Ser45, Thr41, Ser37) beta-ca...	complex	1.0	[none]	cytosol
Phosphorylation of phospho...	ADP_cytosol_3	ADP	smallMolecule	1.0	ADP	cytosol
Phosphorylation of phospho...	Phospho_Ser45_Thr41_Ser3...	Phospho-(Ser45, Thr41, Ser37, Ser33) ...	complex	1.0	[none]	cytosol
Phosphorylation of phospho...	Phospho_Ser45_Thr41_Ser3...	Phospho-(Ser45, Thr41, Ser37, Ser33) ...	complex	[none]	[none]	cytosol



Reset and Save



Process and Save



Process and Proceed

wnt-signaling.owl

File Edit View Components

Data BioPAX to SBML Conversion Advanced

Conversion Criteria Reactions and Participants Compartments

Compartment / Location	Spatial Dims	Surrounding / Outside
cytosol	3	[none]

[none]
cytosol

Reset and Save Process and Save Process and proceed

Systems Biology Linker (SyBiL)

- <http://vcell.org/biopax>
- SyBiL provides capabilities for:
 - Visualizing, analyzing and querying pathway data represented in BioPAX
 - Creating computational model (SBML) from qualitative description (BioPAX)
 - **Converting, gluing and merging data and models about pathways coming from different sources, such as BioPAX and SBML.**
 - Intelligent visualizing and modular presentation of VCell model.

Systems Biology Pathway Exchange (SBPAX)

(a) Converting

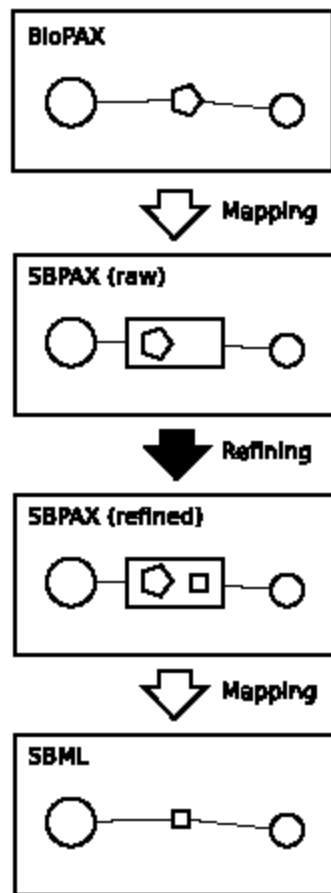

(b) Gluing

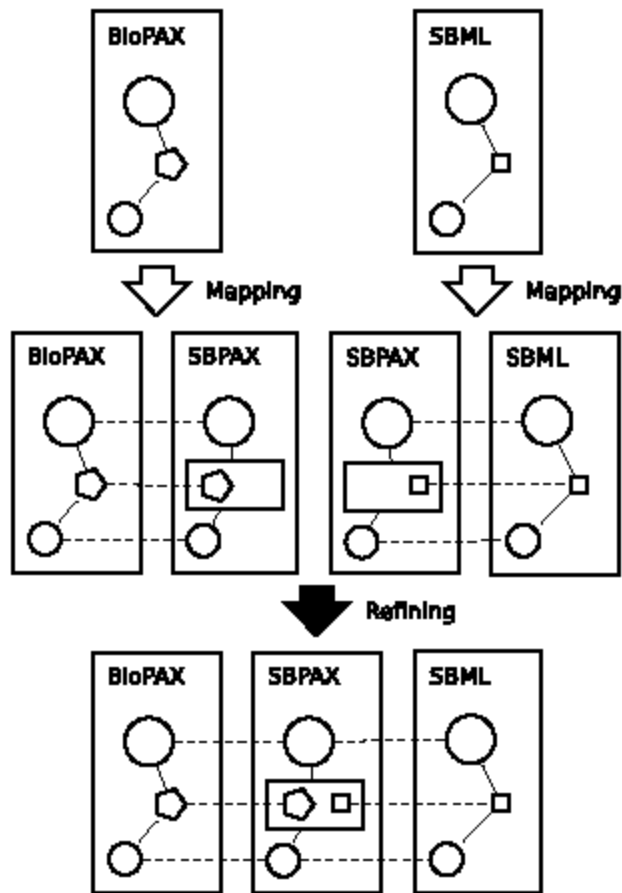

(c) Merging

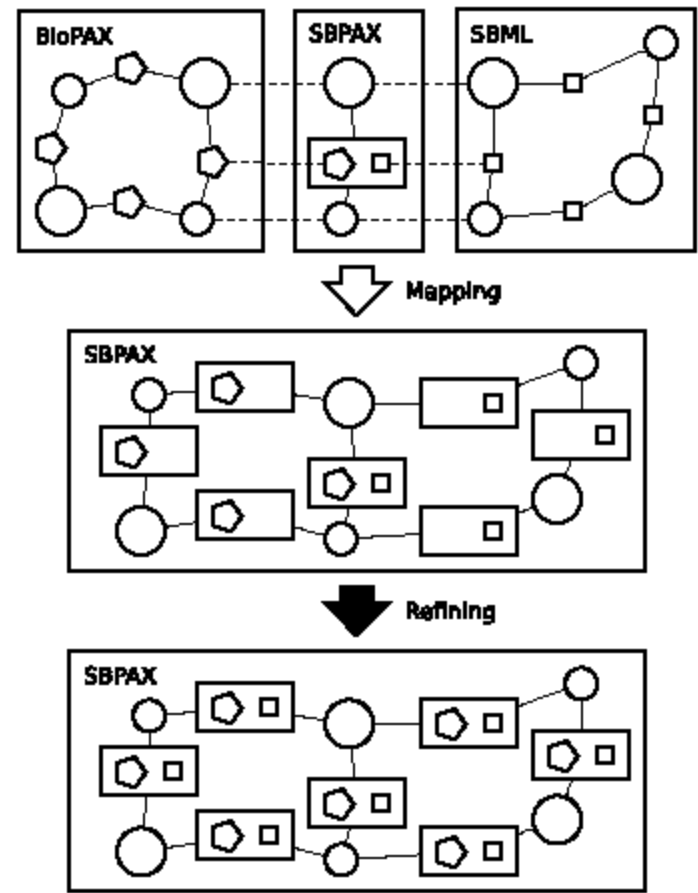

Systems Biology Linker (SyBiL)

- <http://vcell.org/biopax>
- SyBiL provides capabilities for:
 - Visualizing, analyzing and querying pathway data represented in BioPAX
 - Creating computational model (SBML) from qualitative description (BioPAX)
 - Converting, gluing and merging data and models about pathways coming from different sources, such as BioPAX and SBML.
 - **Intelligent visualizing and modular presentation of VCell model.**

Extension of the Virtual Cell: meta-model

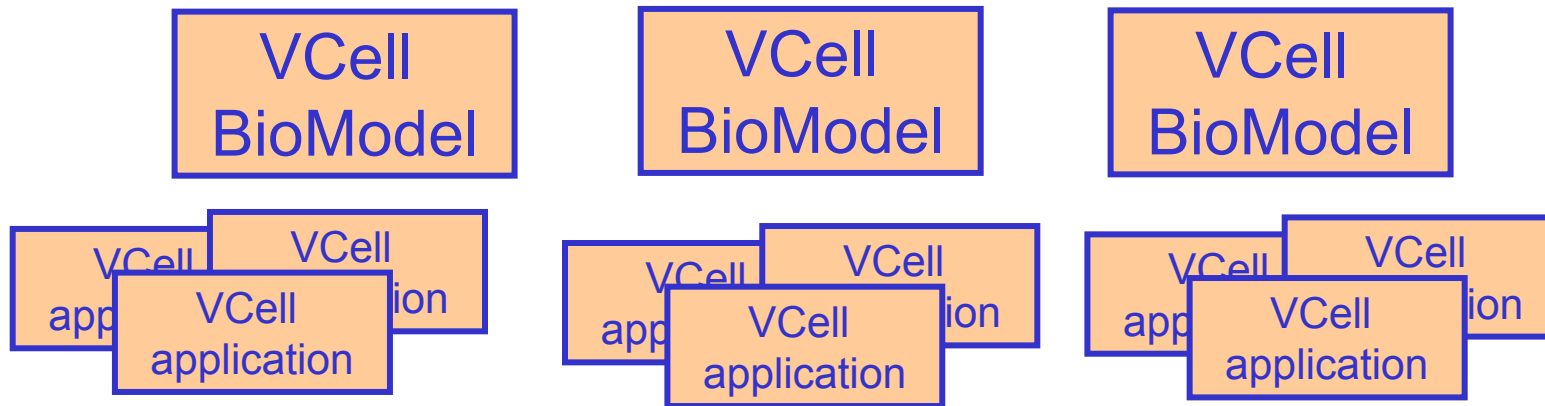
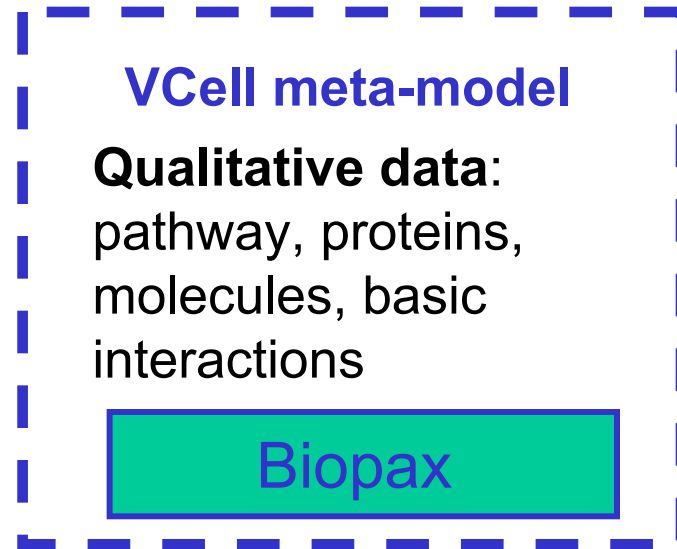

Acknowledgements

BioPAX

- C. Sander (Memorial Sloan-Kettering Cancer Center)
- Emek Demir (Memorial Sloan-Kettering Cancer Center)
- G. Bader (University of Toronto).

BioPAX OBO

- Alan Ruttenberg (Science Commons)
- Jeremy Zucker (Harvard)
- Joanne Luciano (Harvard)